

НАВИС В БОТАНИЧНОМУ САДУ ІМЕНІ М.М. ГРИШКА

ФАСАД 1-4 М 1:50

ФАСАД 4-1 М 1:50

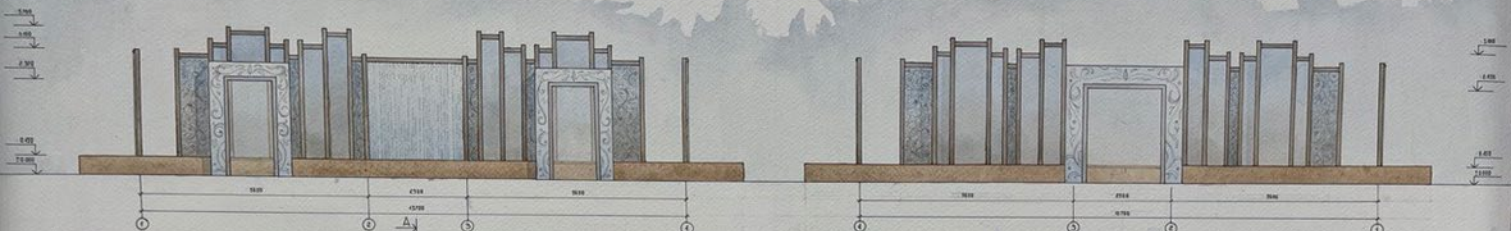

РОЗРІЗ А-А М 1:50

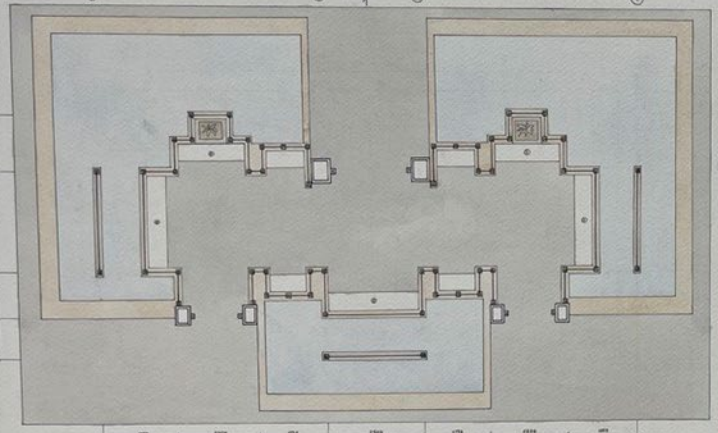
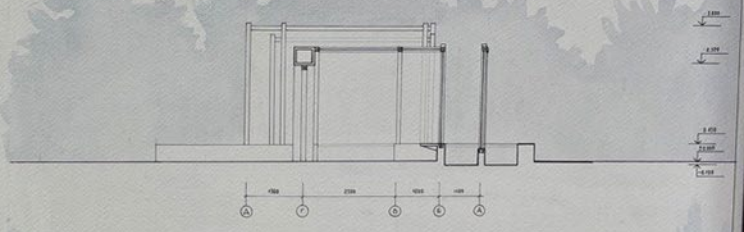

ПЛАН М 1:50  
СИТУАЦІЙНИЙ ПЛАН М 1:2000

ГЕНЕРАЛЬНИЙ ПЛАН М 1:500

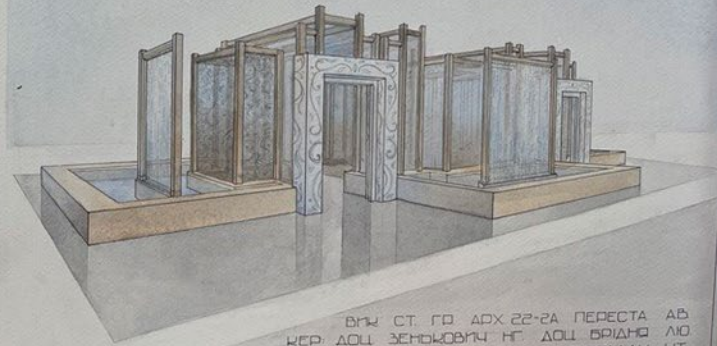

ВНУ СТ. ГО АДХ 22-2А ПЕРЕСТА АБ  
КЕР ДОЦ ЗЕНКОВИЧ НГ ДОЦ БРИДНО ЛЮ  
ДОЦ ЯКОБОВИЧ ЕЛ АС ГАЛАШ НТ.

ЕКСПЛІКАЦІЯ 1-АЛЕЯ 2-НАВИС 3-ЗАМОЩЕННЯ 4-ФОНТАН 5-ЛАВКА

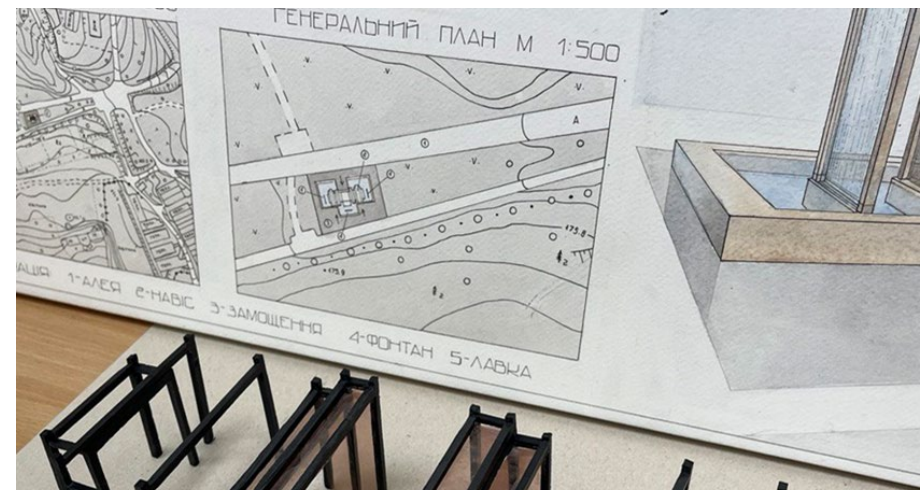

1-АЛЕЯ 2-НАВИС 3-ЗАМОЩЕННЯ 4-ФОНТАН 5-ЛАВКА



# ПАРКОВА ПЛОЩАДКА ДЛЯ ВІДПОЧИНКУ З НАВІСОМ

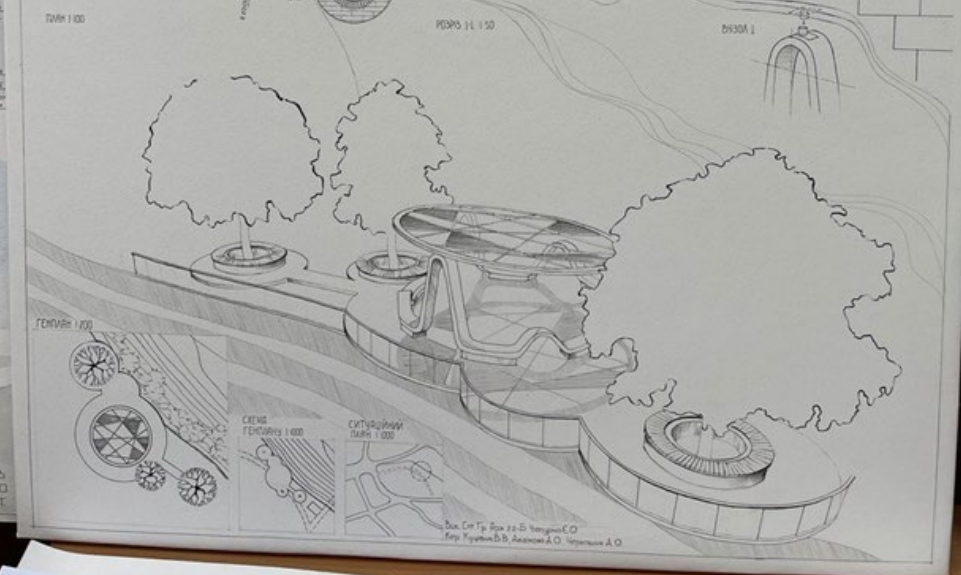
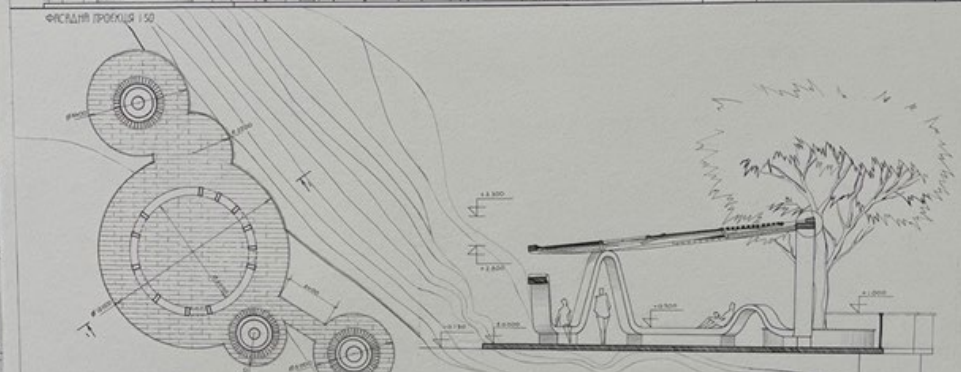
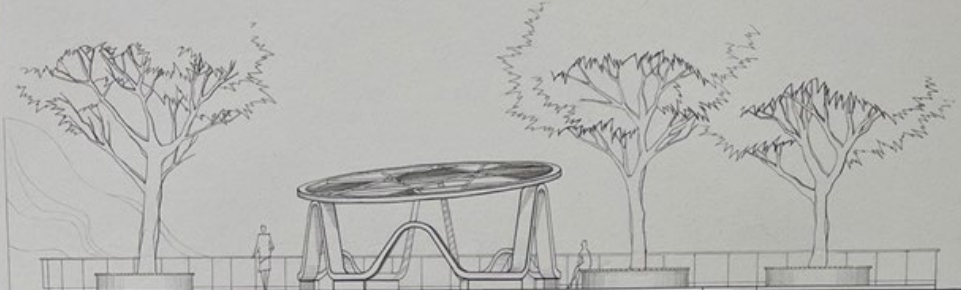

Док. Сп. Гр. Проєкт. С.В. Шевченко С.О.  
Бер. Кривий Ріг, Архитект. А.О. Шевченко А.О.



Поповичко Д. П.  
Арх. 22-24



НАВИС У БОТАНИЧНОМ САДУ  
И.М.М. ГРИЦУА

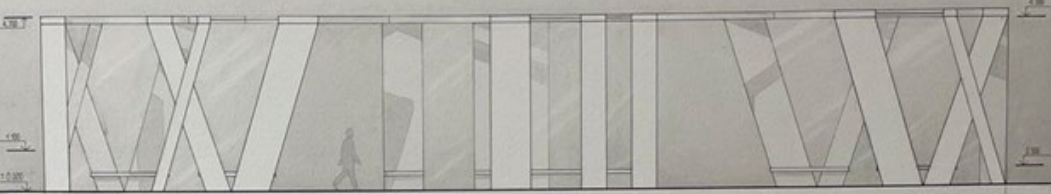

ФАСАД 1-С М 1:50

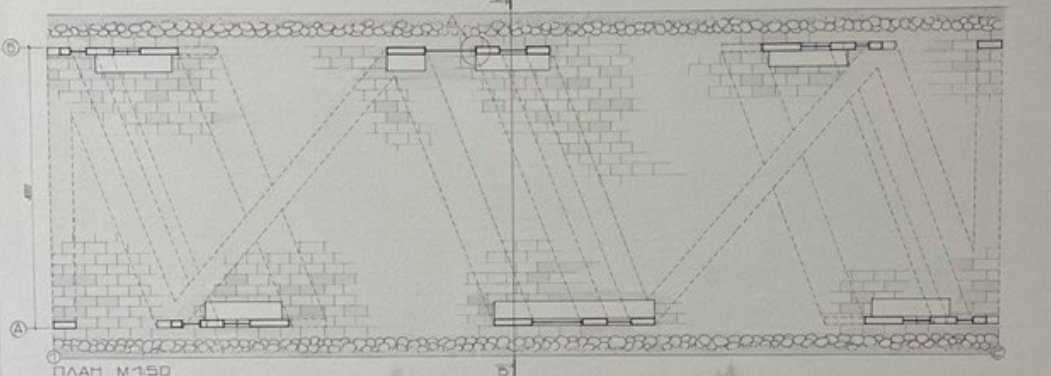

ПЛАН М 1:50



ГЕНЕРАЛНИЙ ПЛАН М 1:500  
Б.С. ПЛАНИРОВАНИЕ  
1-АЛЕЯ 2-ГАЗОН 3-НАВИС



ФАСАД А М 1:50



РОЗРІЗ Б-Б М 1:50



СИТУАЦІЙНИЙ ПЛАН М 1:5000

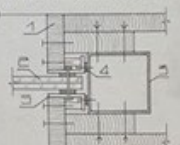

АСТАЛДА М 1:25  
1-ДЕРЕВО 2-СЧЛД 3-МЕТАЛ  
4-ШЛАКОВА БИТАВЛА  
5-ПЕРЖАКОВАНИ ЦИТРИ

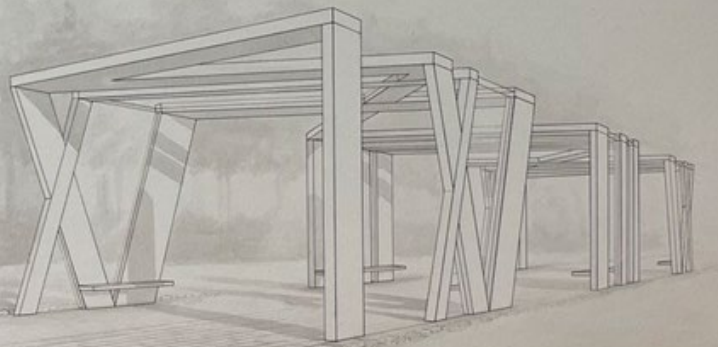

Б.П. С.Т. Г.Р. АРХ-22-24 ШАНП Д.Б.  
ЧЕР.ДОЦ. ЗЕРКОВИЧ П.Г. ДОЦ. БРИАНС Л.В. ДОЦ. ЯКОБОВИЧ Е.А. АС. ГАЛАН У.Т.



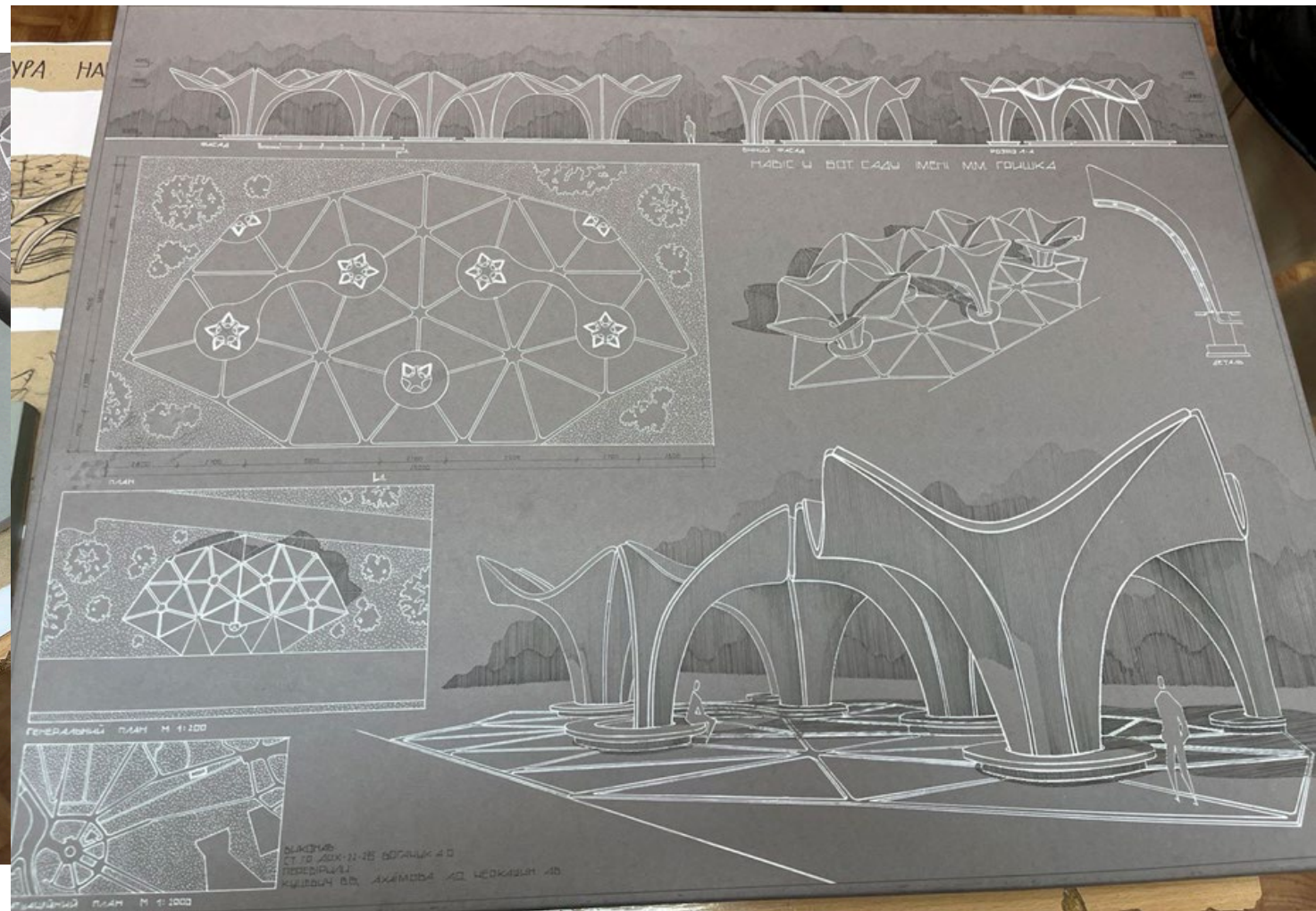
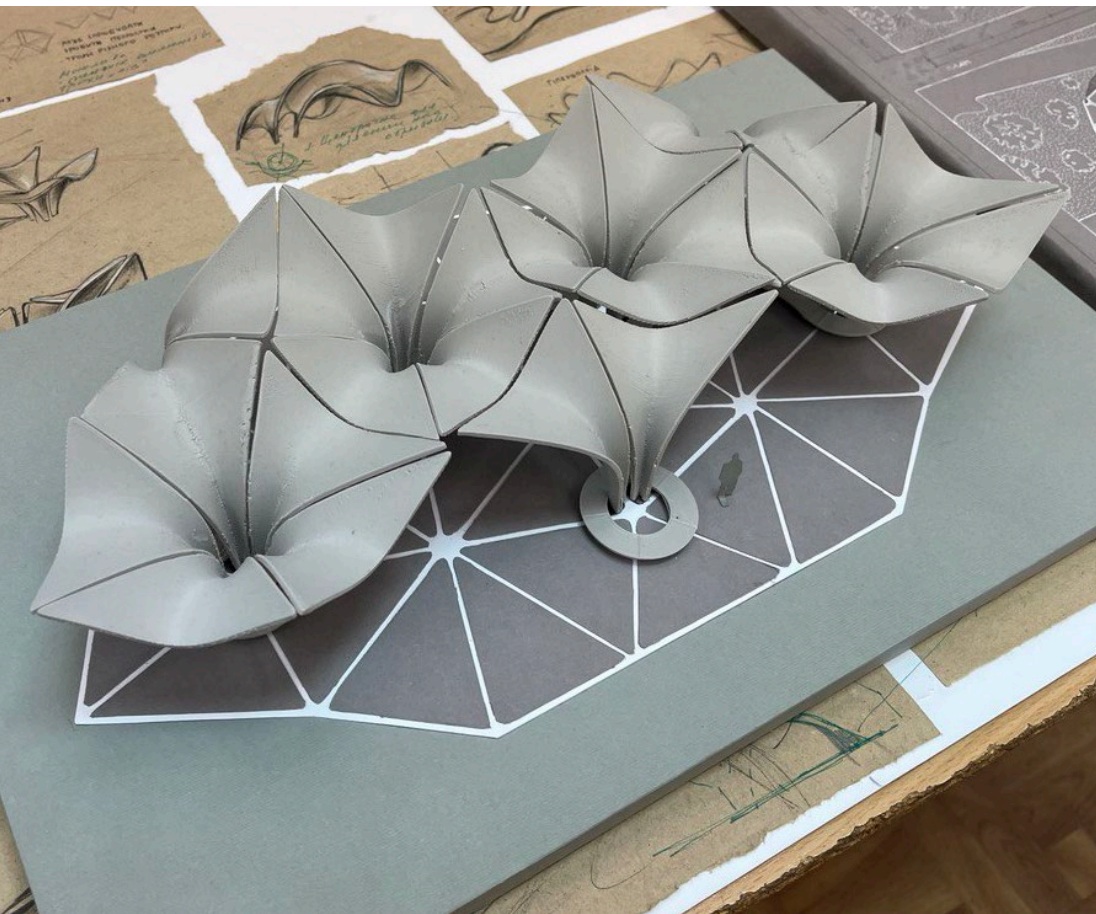

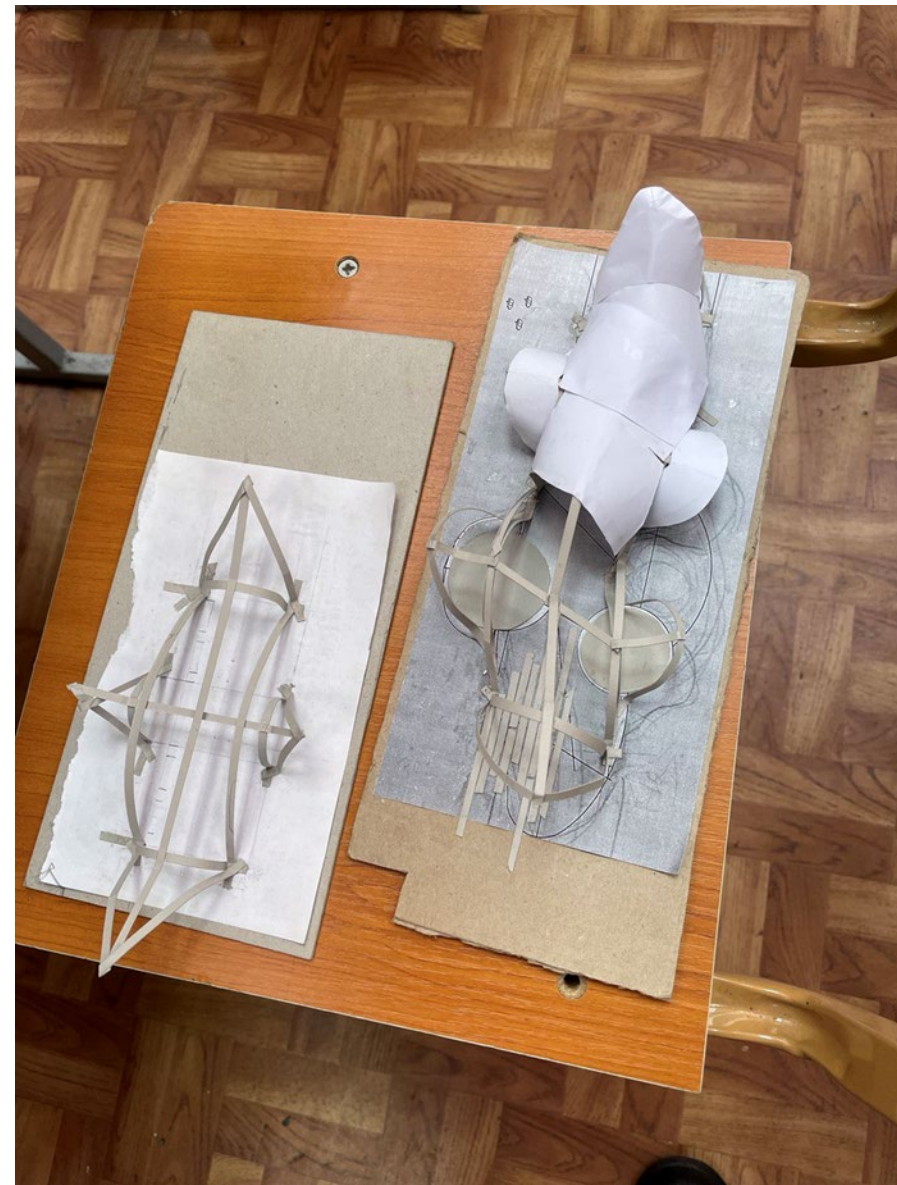

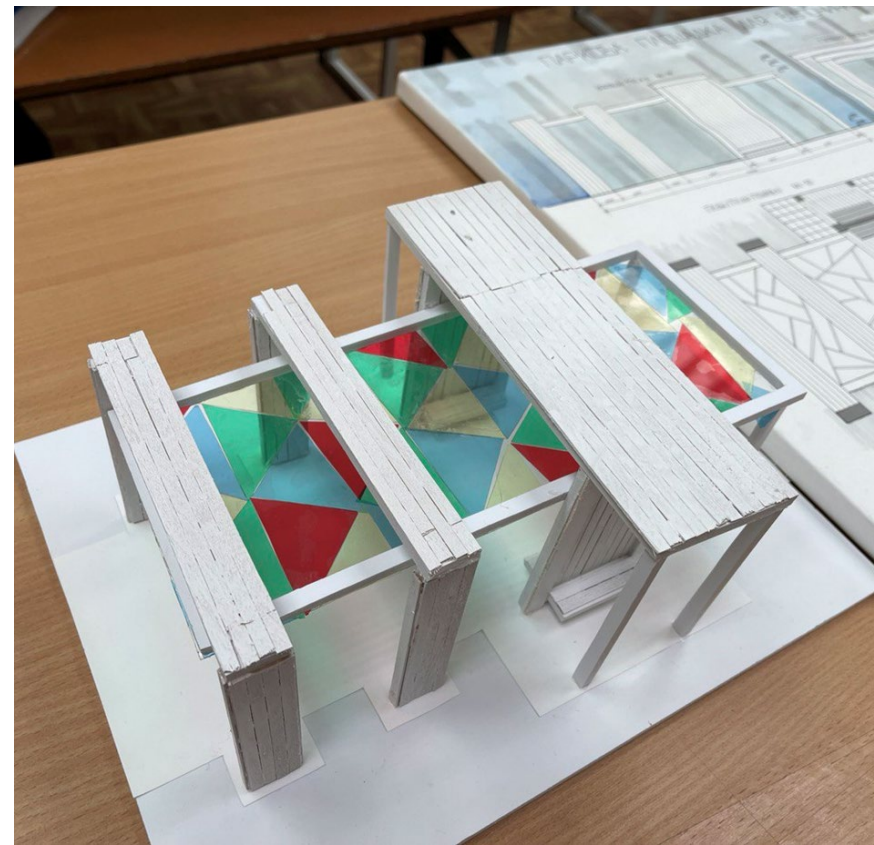
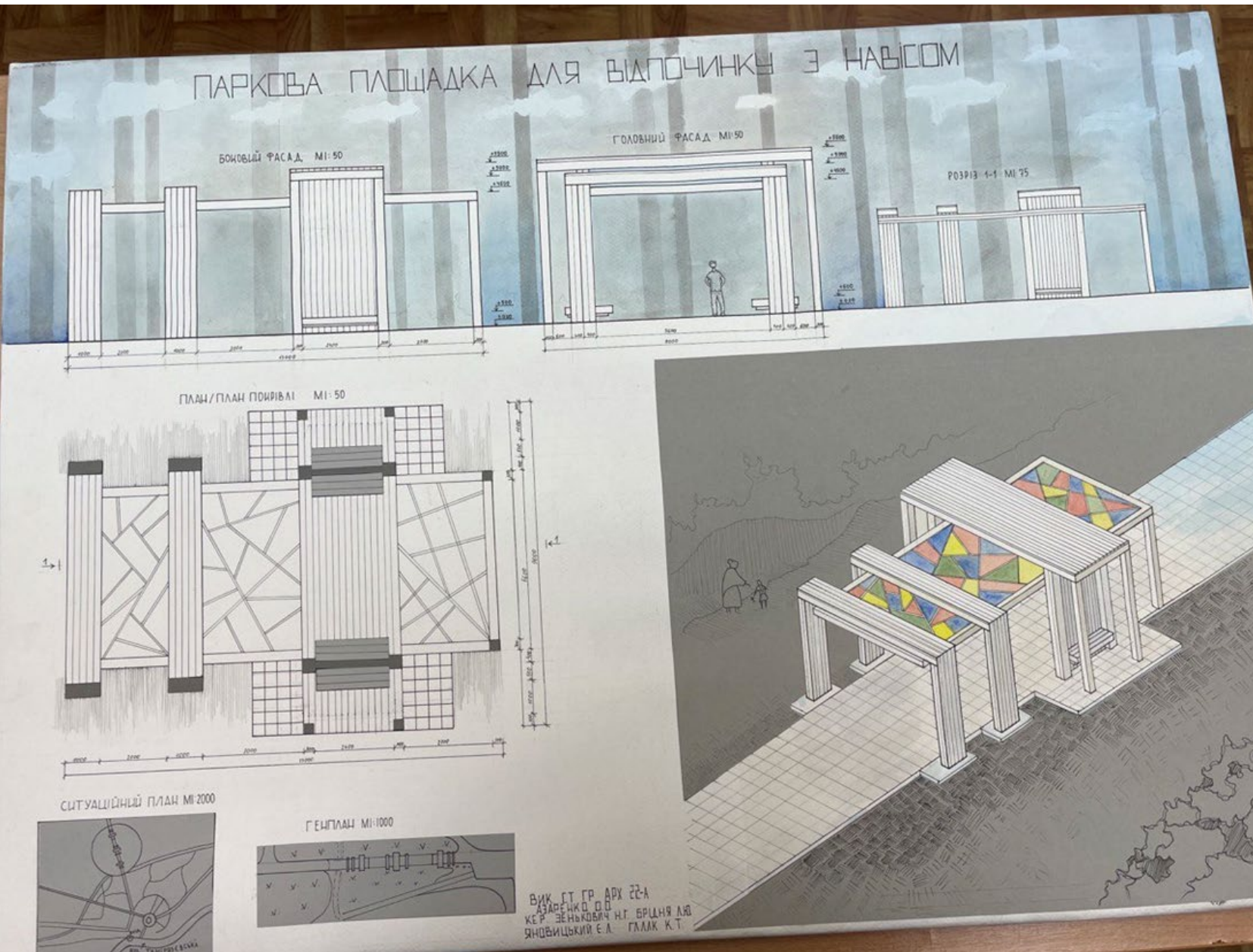

ПЕРГОЛА В БОТАНІЧНОМУ САДУ ІМЕНІ М.М. ГРИШКА

Фасад 1-8 М1:75

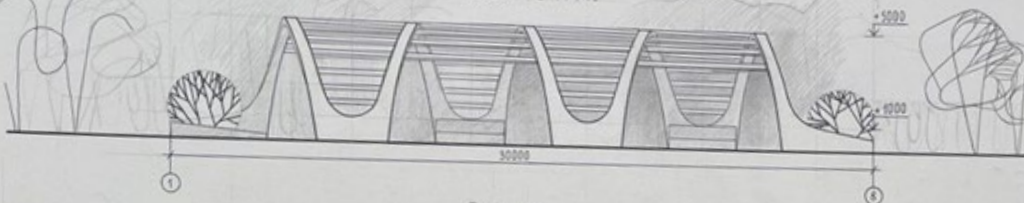

План М1:75

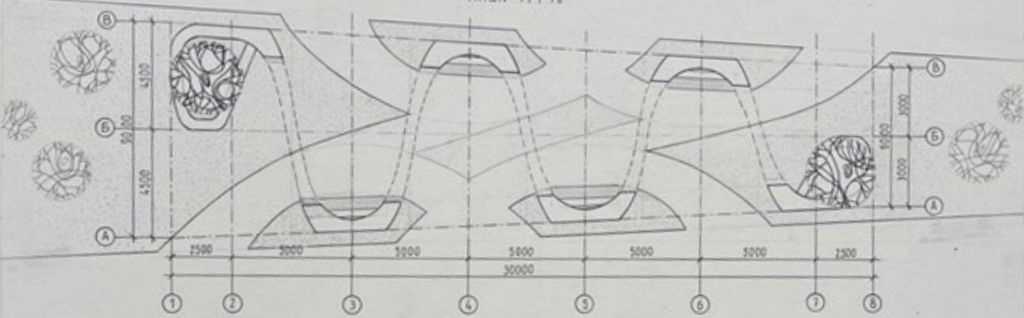

Ситуаційна схема М1:2000

Генплан М1:200

Фасад В-А М1:75

Фрагмент розрізу М1:75

